

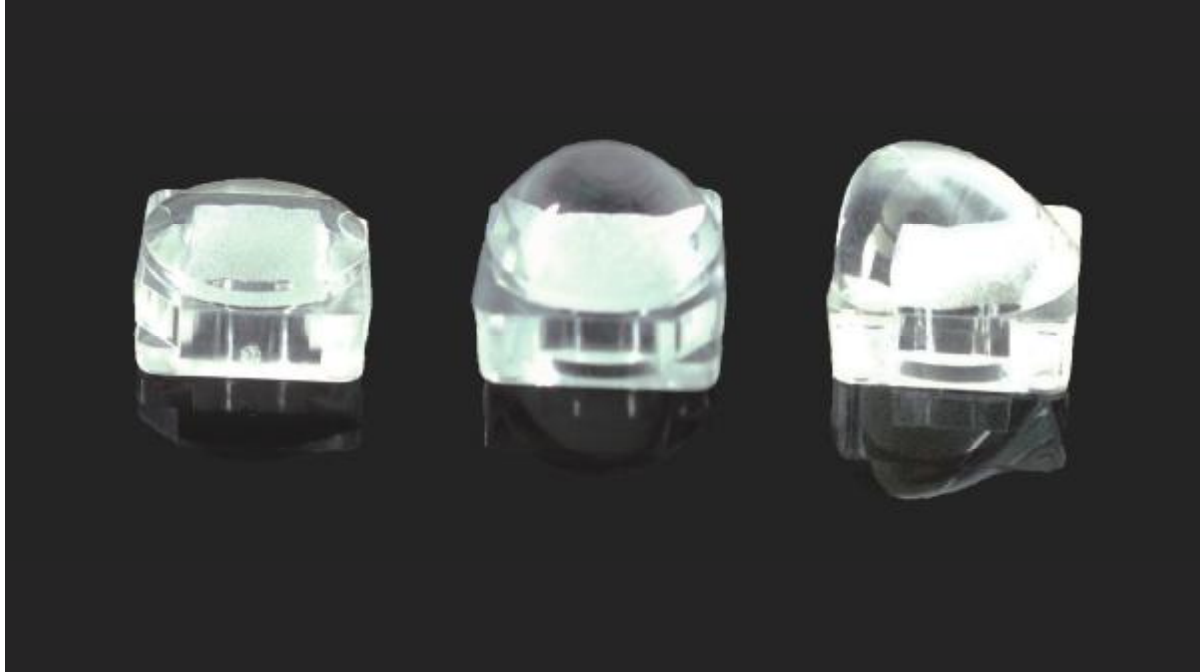

YML01ZZ-GXxxF LENS



PRODUCT DESCRIPTION

Features:

- High efficiency >93%
- Available in 4 beam pattern
- Optimized for uniform effects
- Lens material Optical grade PMMA
- Lens without holder

Typical applications:

- Stage Lighting
- Street Lights
- Decorative Light
- Down Light

TABLE OF CONTENTS

General Information	2
Usage and Maintenance	2
2D Drawings	3-6
Optical Characteristics (for 5050 led)	3-6
Package Information	7
Product Nomenclature	8



General Information (T_J = 25°C)

- **Compatible Led Type:**

The YML01ZZ-GXxxF single lens is optimized for 5050 led .

- **Beam Angle Type:**

An optimized profile integrate different front shape enabel the general of four lens model:oval beam (45deg;60deg;90deg and PG60deg) ⁽¹⁾

- **The Way to Assembly:**

The lens should be assembled to the PCB board or MCPCB upon LEDs which provides the most appropriate related position,so as to achieve the best uniform results.

*** Manually installation or if necessary thermal glue are recommended.**

- **Fuction:**

YML01ZZ-GXxxF provides excep tional color mixing result with the highest efficiency through careful enginnering and precision manufacturing process.

Usage and Maintenance

- 1.Clean lenses with mild soap and water and a soft cloth.
- 2.Don't use any commercial cleaning solvents on lenses,like alcohol.
- 3.Operating temperature -40°C ~+80°C (upper limit +90°C)
- 4.please handle or install lenses with wearing gloves,skin oils may damage lens or optical characteristic.

Notes:

(1) Typical beam divergence will be affected by different LED manufacturers.



2D Drawings (unit:mm)

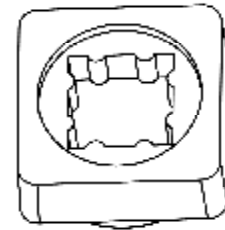
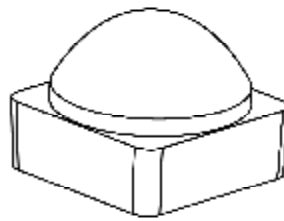
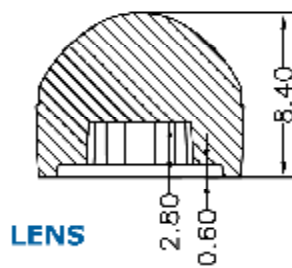
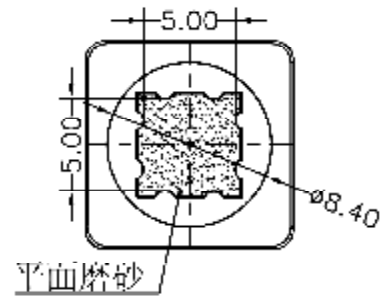
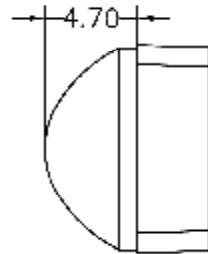
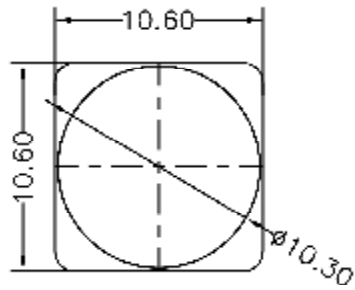

Optical Characteristics (for 5050 LED)

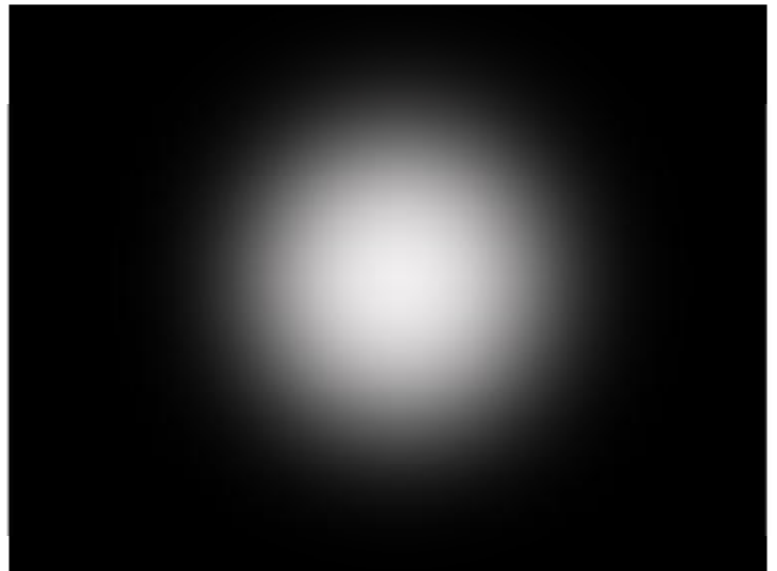
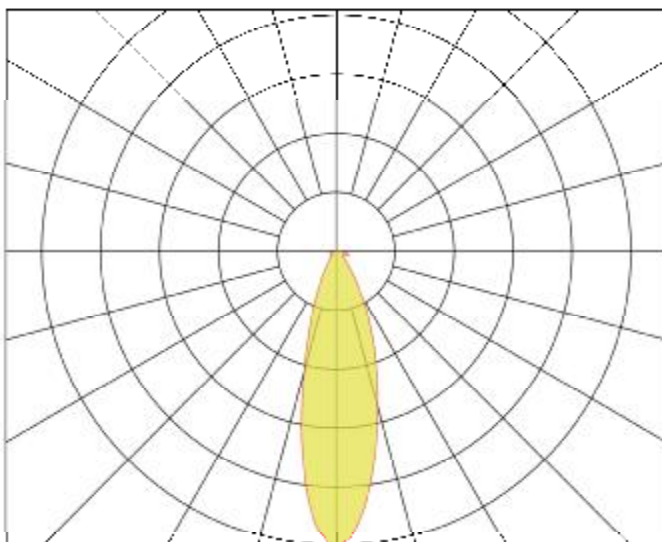

Note: The LED emitter flux is 120lm @350mA



2D Drawings (unit:mm)

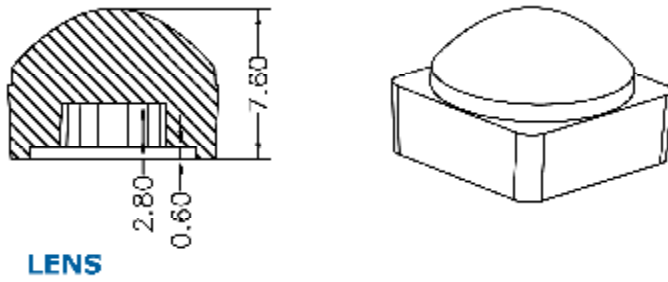
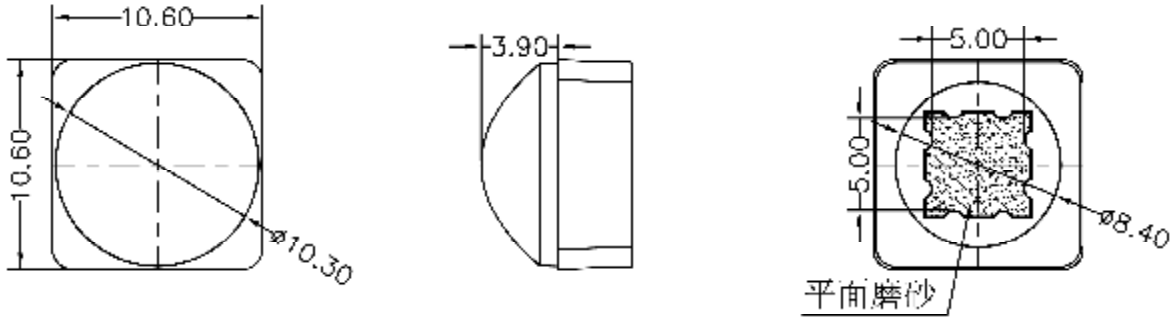

Optical Characteristics (for 5050 LED)

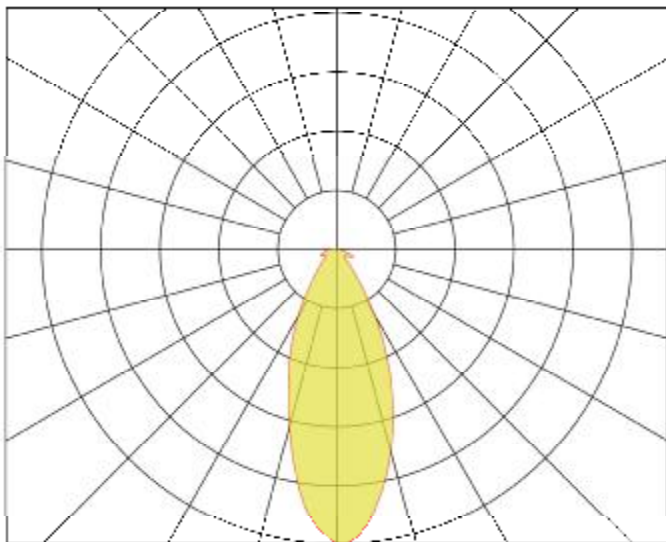

Note: The LED emitter flux is 120lm @350mA



2D Drawings (unit:mm)

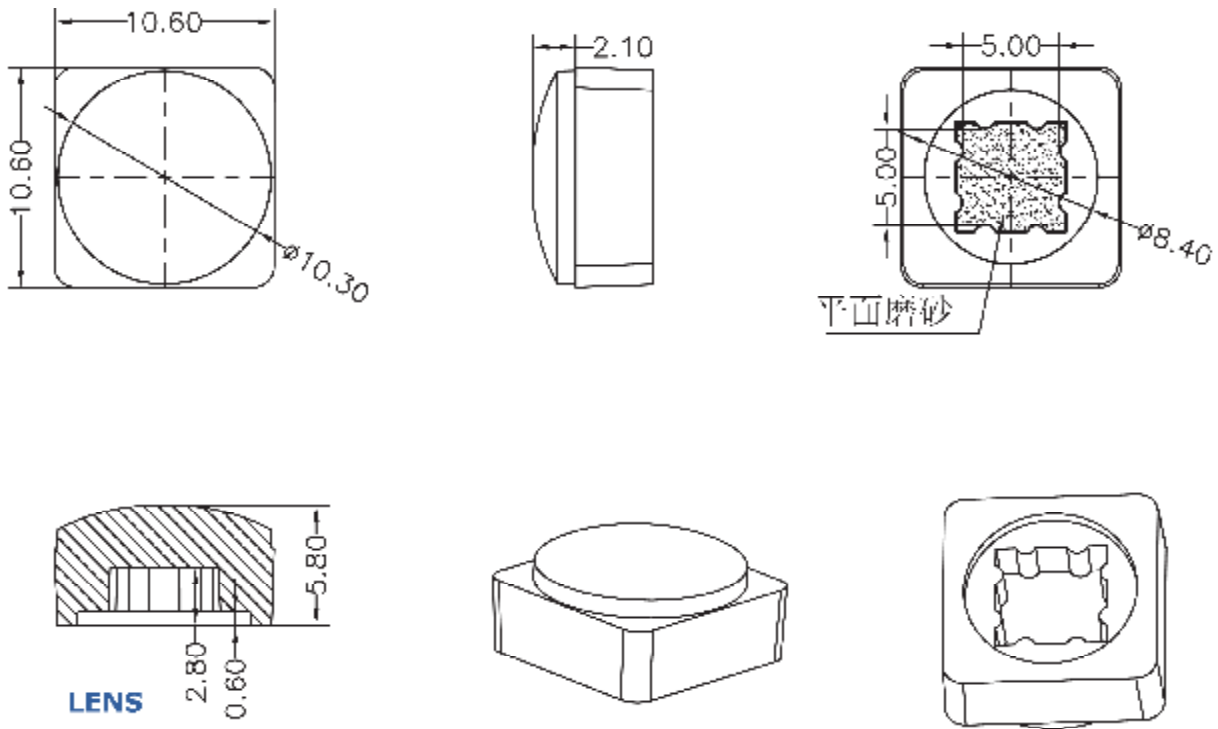

Optical Characteristics (for 5050 LED)

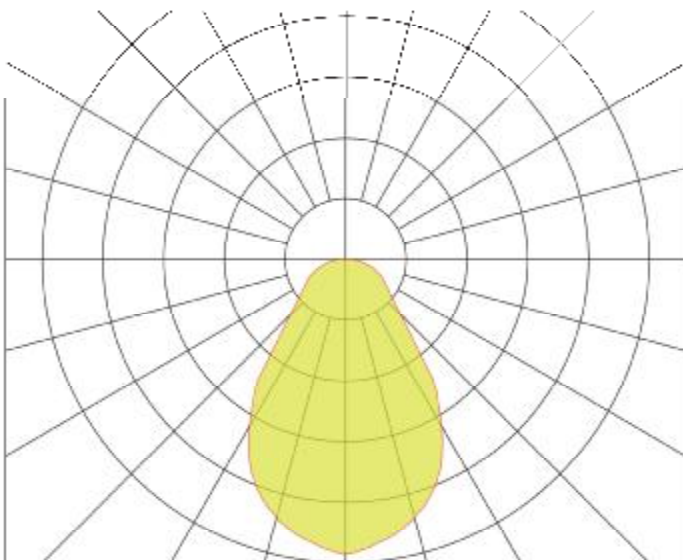

Note: The LED emitter flux is 120lm @350mA



2D Drawings (unit:mm)

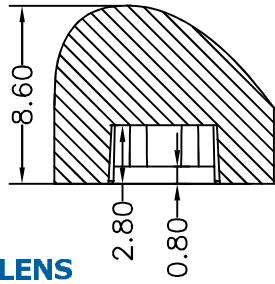
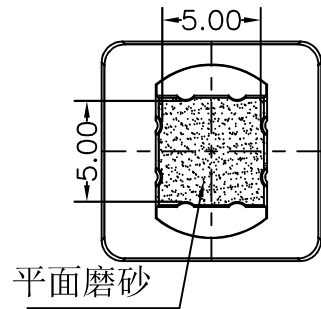
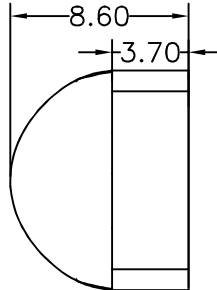
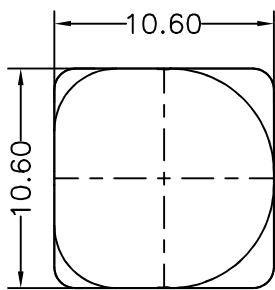

LENS

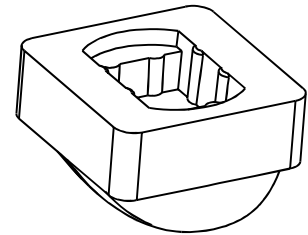
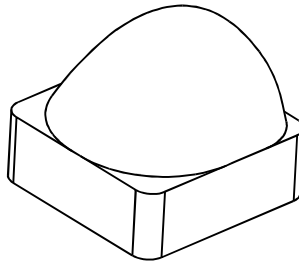

Optical Characteristics (for 5050 LED)

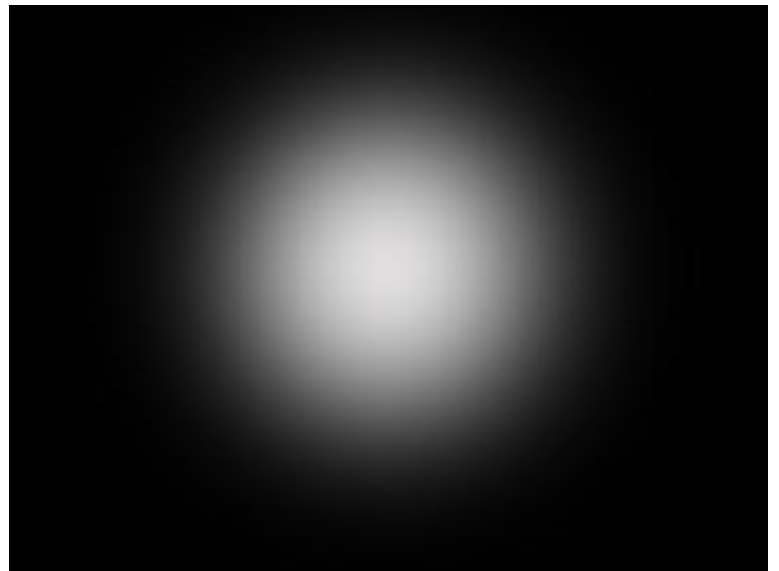
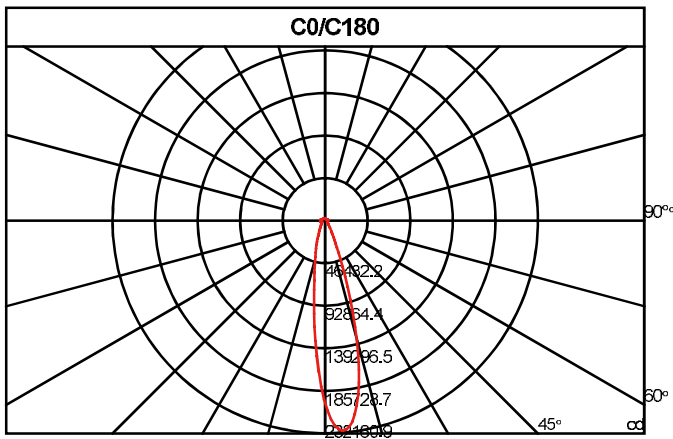

Note: The LED emitter flux is 120lm @350mA



Package Information

Item	Quantity	Total	Size (long*width* high)
Bag	1500pcs/Bag	1500pcs	-
Inner box	1 Bag/inner box	1500pcs	12.5*12.5*12.5 cm
Outer box	18 inner box/outer box	27000pcs	42.0*39.0*39.0 cm

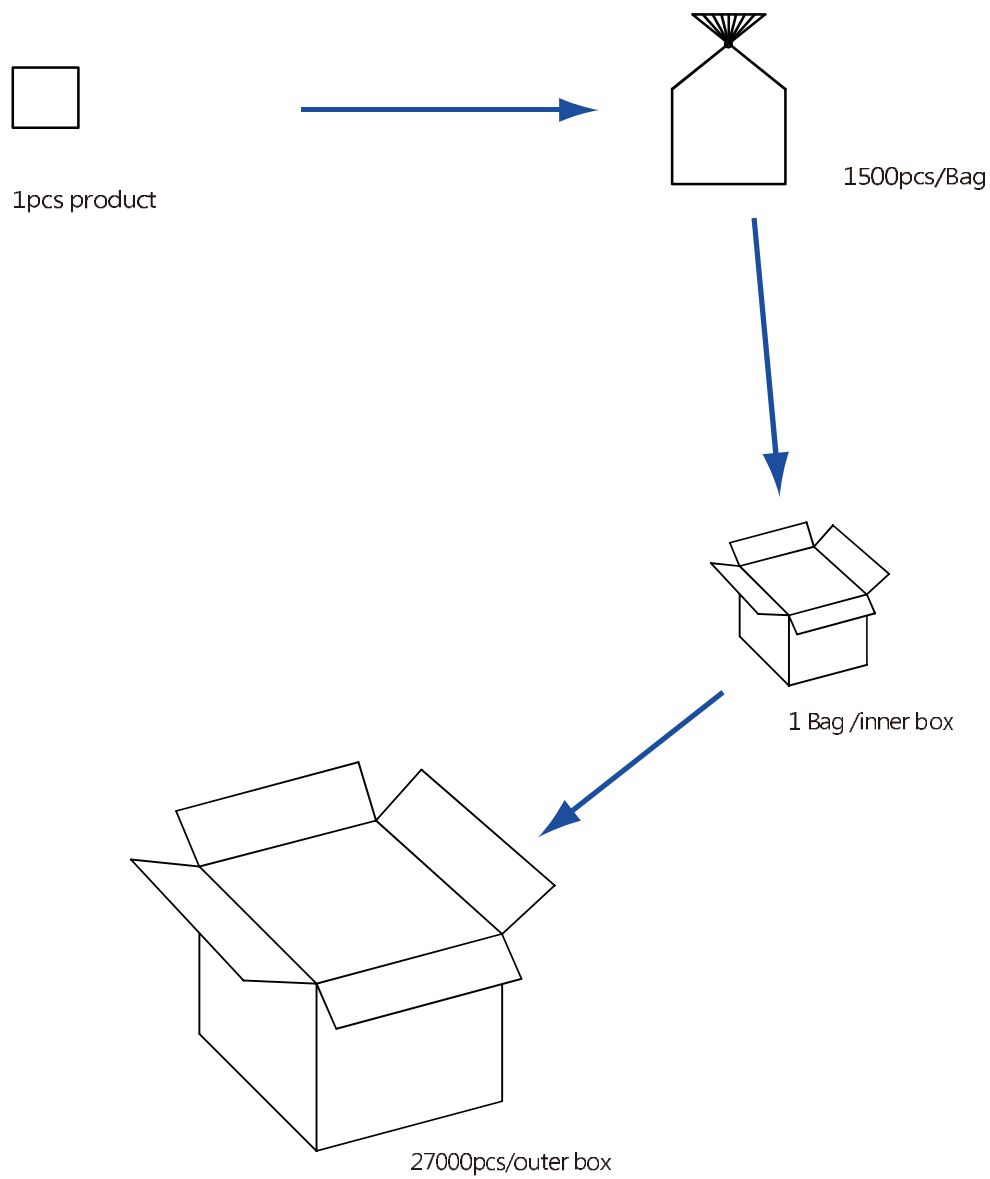



Product Nomenclature

