



## YML01CR-LUxxF LENS



### PRODUCT DESCRIPTION

#### Features:

- High efficiency >93%
- Available in 4 beam pattern
- Optimized for uniform effects
- Lens material Optical grade PMMA
- Lens without holder

#### Typical applications:

- Stage Lighting
- Street Lights
- Decorative Light
- Down Light

### TABLE OF CONTENTS

General Information	.....	2
Usage and Maintenance	.....	2
2D Drawings	.....	3-6
Optical Characteristics (for 3535 led)	.....	3-6
Package Information	.....	7
Product Nomenclature	.....	8



## General Information (T<sub>J</sub> = 25°C)

---

- **Compatible Led Type:**

The YML01CR-LUxxF single lens is optimized for 3535 led .

- **Beam Angle Type:**

An optimized profile integrate different front shape enabel the general of four lens model:oval beam (15deg;45deg;10\*65deg and 20\*45deg)<sup>(1)</sup>

- **The Way to Assembly:**

The lens should be assembled to the PCB board or MCPCB upon LEDs which provides the most appropriate related position,so as to achieve the best uniform results.

**\* Manually installation or if necessary thermal glue are recommended.**

- **Fuction:**

YML01CR-LUxxF provides excep tional color mixing result with the highest efficiency through careful enginnering and precision manufacturing process.

## Usage and Maintenance

---

- 1.Clean lenses with mild soap and water and a soft cloth.
- 2.Don't use any commercial cleaning solvents on lenses,like alcohol.
- 3.Operating temperature -25°C ~+80°C (upper limit +90°C)
- 4.please handle or install lenses with wearing gloves,skin oils may damage lens or optical characteristic.

## Notes:

(1) Typical beam divergence will be affected by different LED manufacturers.



## 2D Drawings (unit:mm)

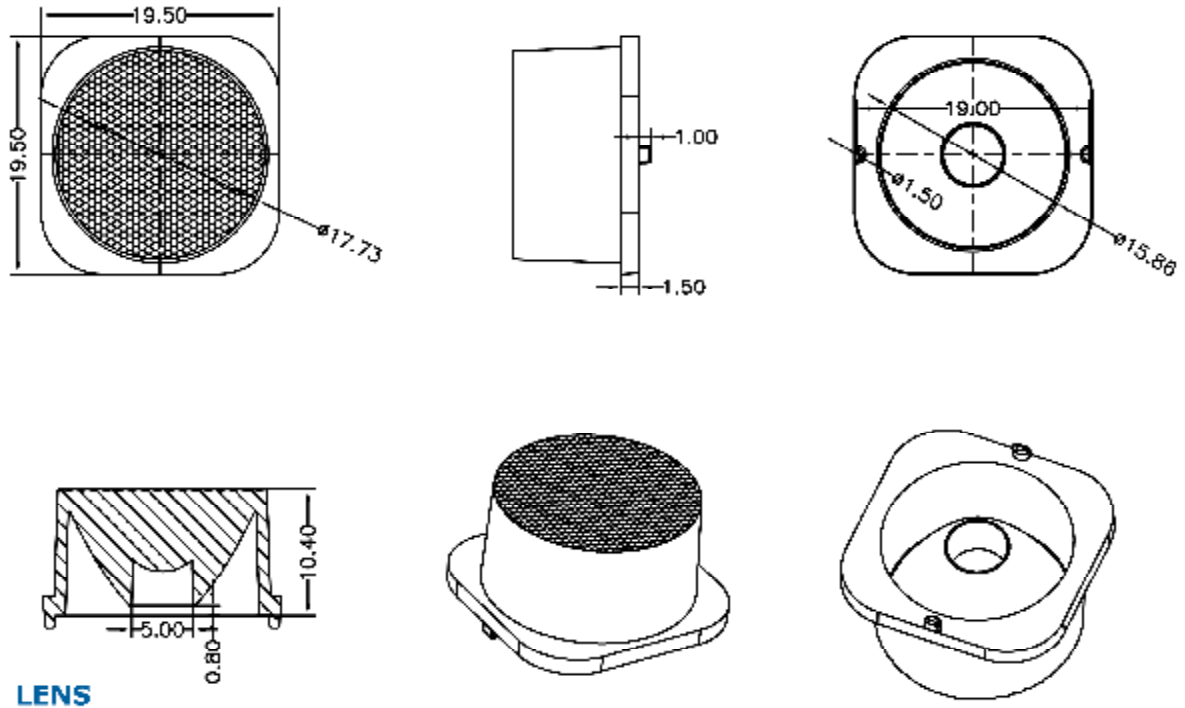

## Optical Characteristics (for 3535 LED)

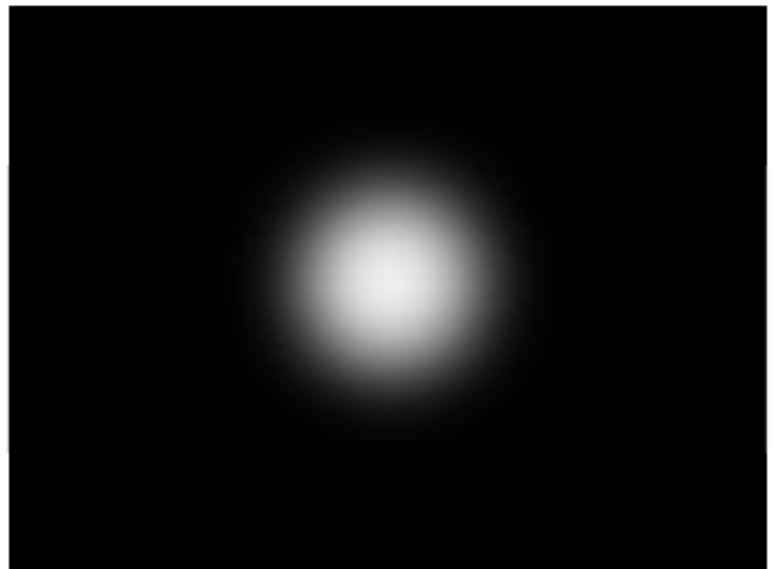
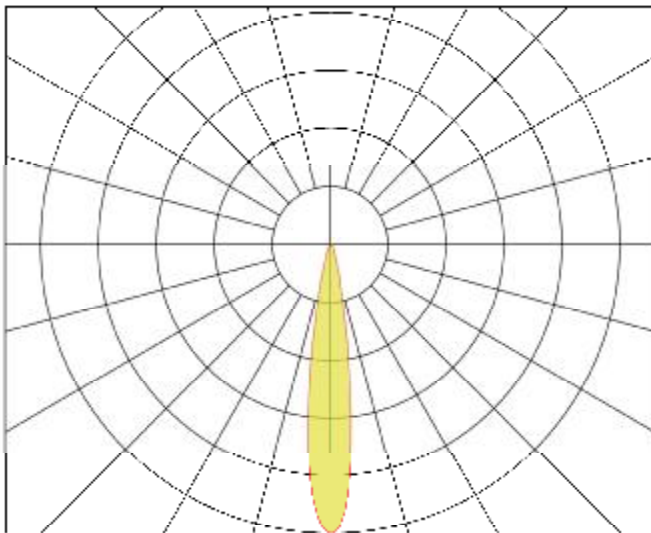

Note: The LED emitter flux is 120lm @350mA



## 2D Drawings (unit:mm)

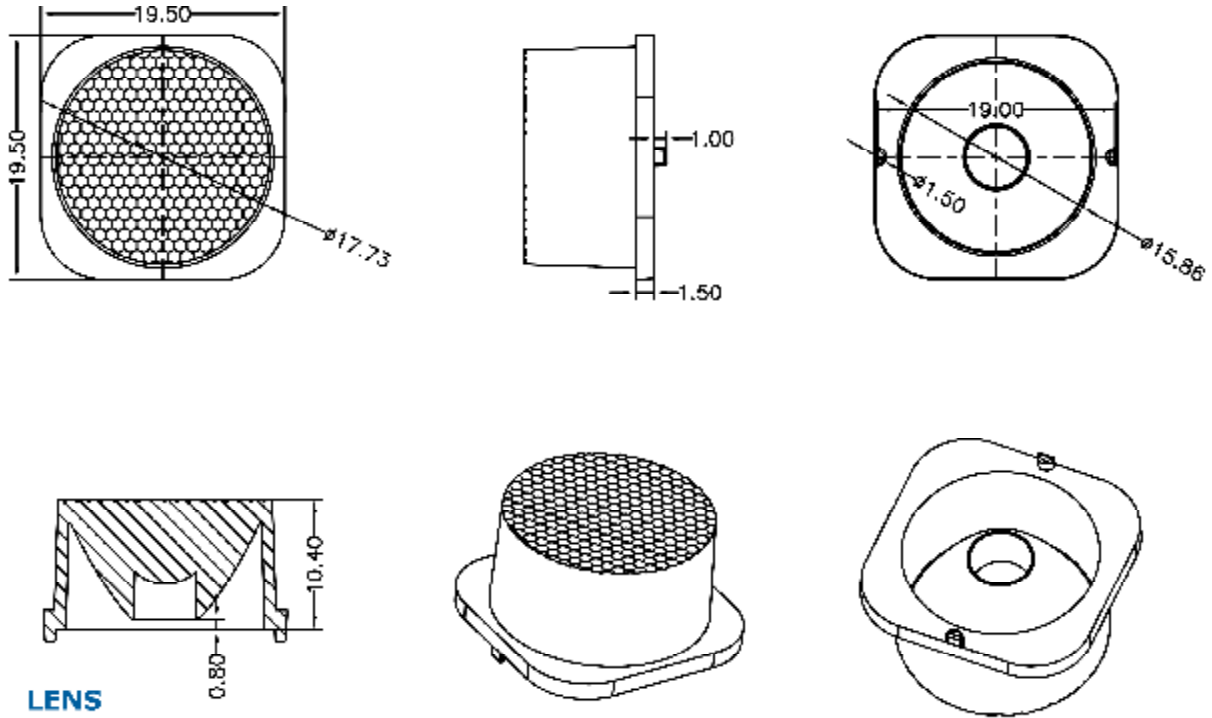

LENS

## Optical Characteristics (for 3535 LED)

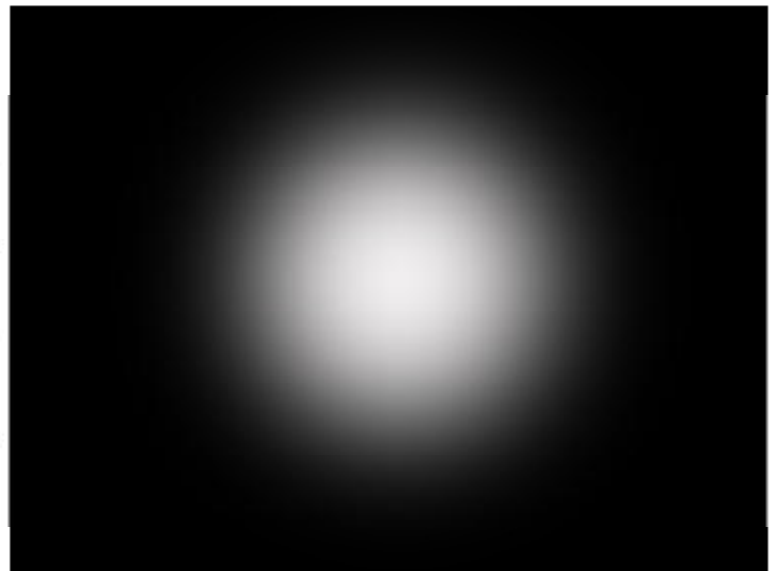
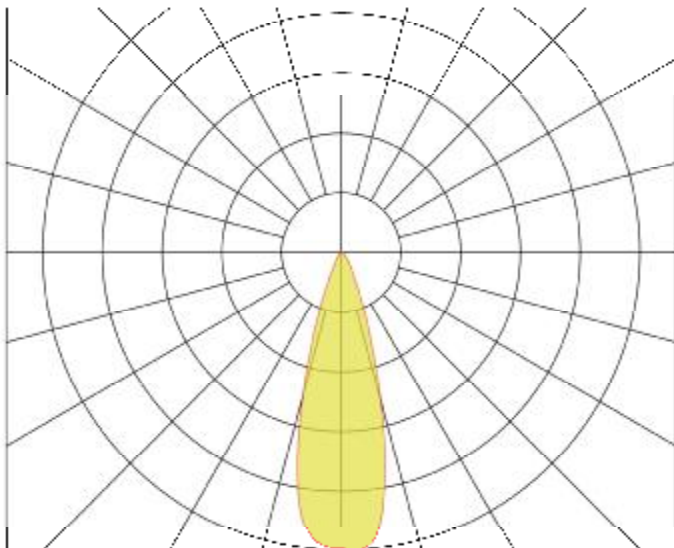

Note: The LED emitter flux is 120lm @350mA



## 2D Drawings (unit:mm)

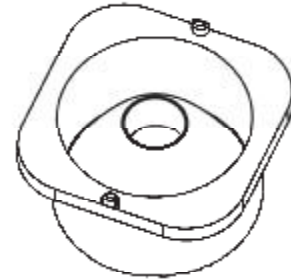
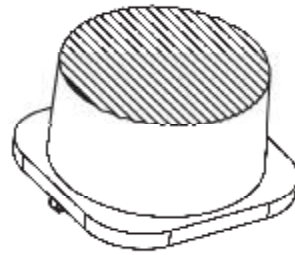
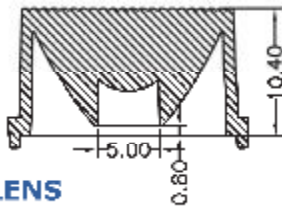
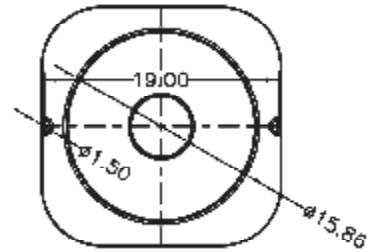
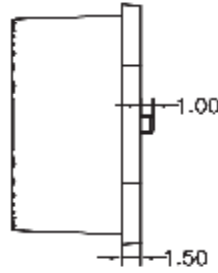
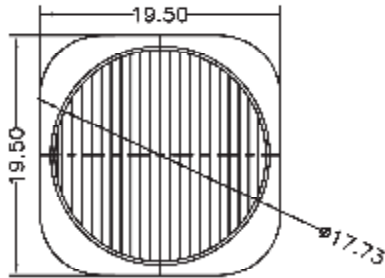

## Optical Characteristics (for 3535 LED)

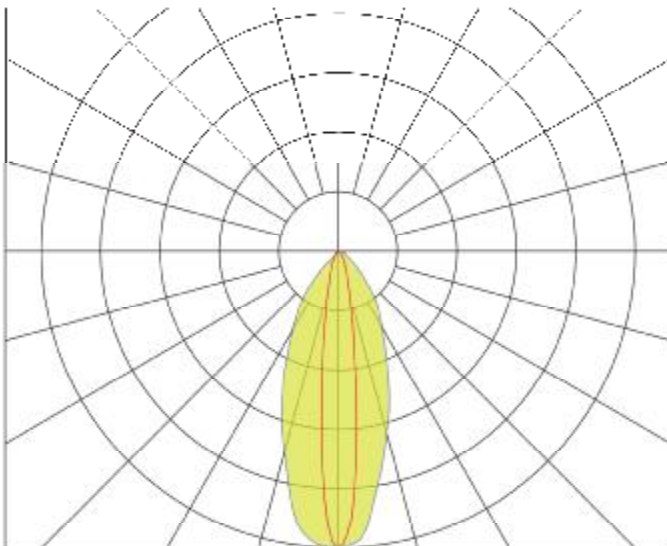

Note: The LED emitter flux is 120lm @350mA



### 2D Drawings (unit:mm)

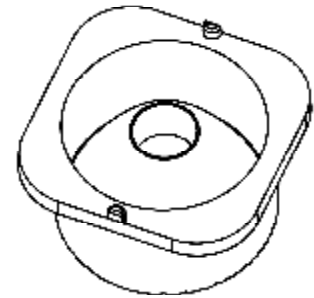
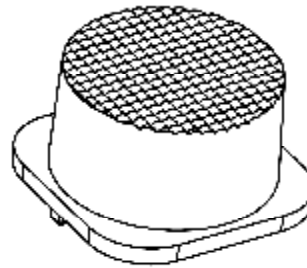
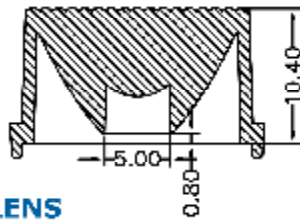
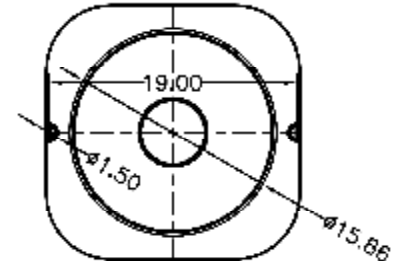
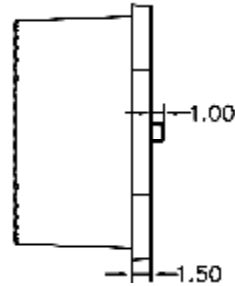
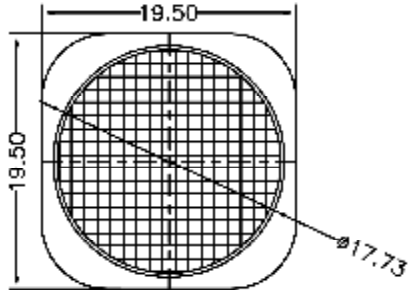

### Optical Characteristics (for 3535 LED)

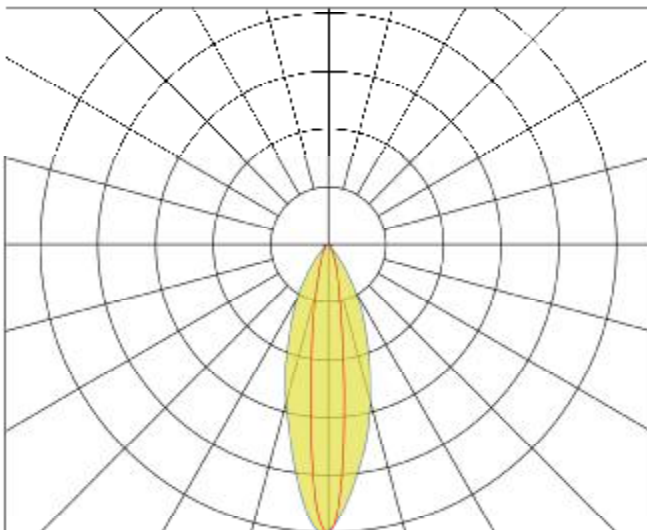

Note: The LED emitter flux is 120lm @350mA



## Package Information

Item	Quantity	Total	Size (long*width* high)
Bag	350pcs/Bag	350pcs	-
Inner box	1 Bag/inner box	350pcs	12.5*12.5*12.5 cm
Outer box	18 inner box/outer box	6300pcs	42.0*39.0*28.0 cm

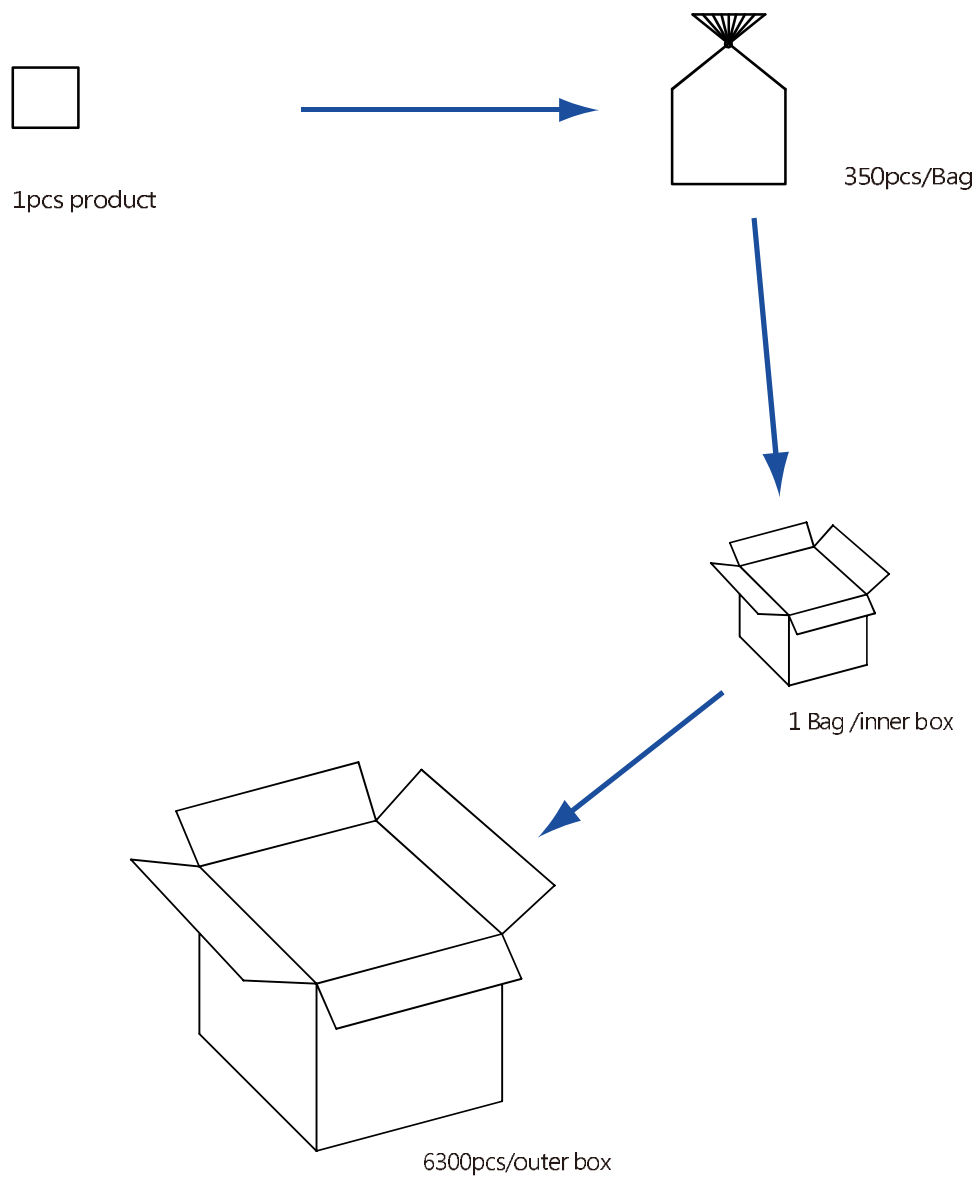



Product Nomenclature

